

规格书

SPECIFICATION

CUSTOMER NAME 客户名称 : _____



CUSTOMER NO. 客户编号 : _____

SERIES 系 列 : TACT SWITCH

MODEL NO. 型 号 : TS5252-AADF-S4W26A

If specification of this product meets your request, please confirm all the items of it and return to us with signature and stamp, it will be basis of our production and record. Thanks your cooperation in advance!

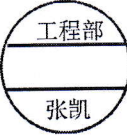
若此产品规格符合贵公司要求, 敬请确认次规格书内所有项目并签名和盖章后回传给我司, 以作我司产品制作之依据和存档之用, 多谢合作!

EXAMINE & APPROVAL 审批			
APPROVE 接受		NOT APPROVE 不接受	
SIGNATURE 签署 STAMP 盖章 DATE 日期		SIGNATURE 签署 STAMP 盖章 DATE 日期	
PREPARED BY.制表人	CHECKED BY.校对	APPROVED BY.审核	NO.
 工程 部 张凯	 品质 部 林化	 工程 部 傅云峰	

REV.	DESCRIPTION	DATE	DRAWN	CHECKED	APVD.
A		18/04/13	Yong Zeng	Kai Zhang	Yunfeng Fu

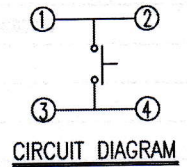

Without any banned substance! Compliance with RoHS!

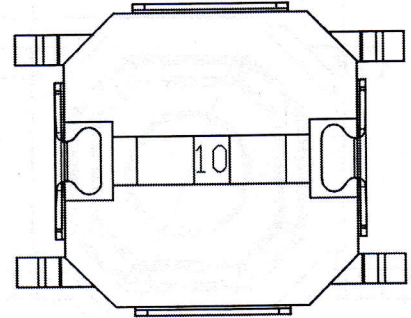
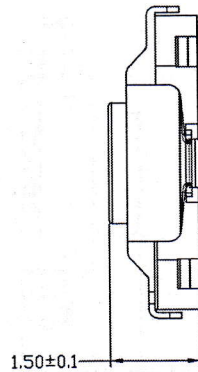
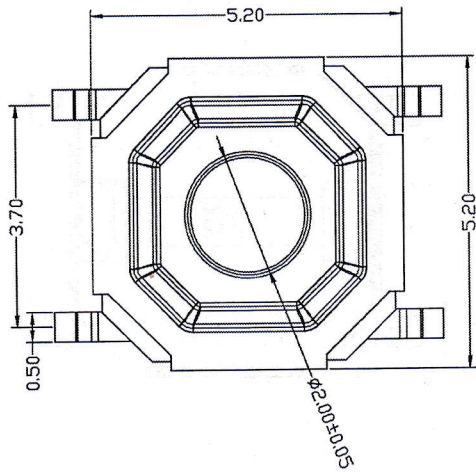

0.25 PUSH TRAVEL

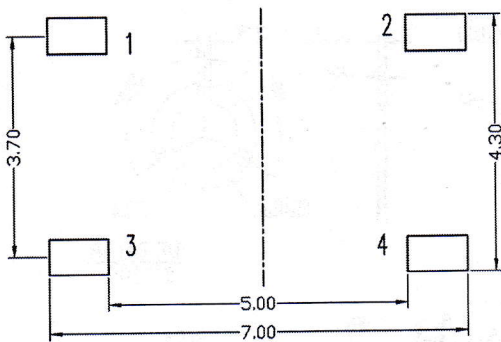
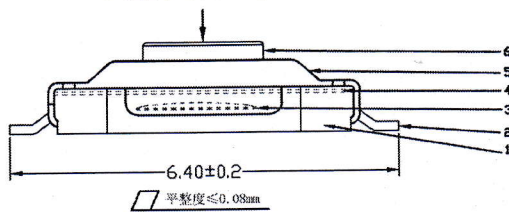

Recommended PAD Layout $\phi \pm 0.05$
Recommended solder thickness: $T=0.10 \pm 0.01$

1. RATING: DC 12V, 50mA Max
2. OPERATING FORCE: 260 ± 40 gf
3. TRAVEL: 0.25 ± 0.1 mm
4. LIFE: 100,000 cycles
5. PACKAGE: 4000Pcs/Reel

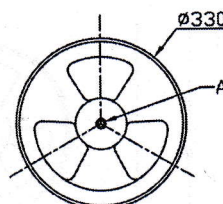

SC 1:150

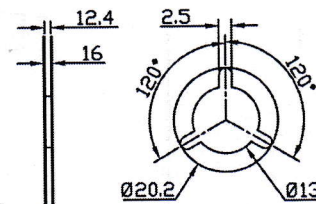

DETAIL A
SC:10:1

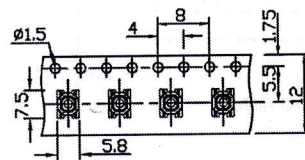

SC 1:10



编带的透明带剥离强度标准: 30~100gf

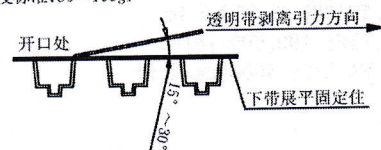

ITEM	PART NAME	Q'TY	MATERIAL	FINISH	BEST TECHNOLOGY CO., LTD					
6	KNOB	1	BRASS	YELLOW	TOLERANCES UNLESS OTHERWISE SPECIFIED	CLASS:				
5	COVER2	1	SUS	NATURAL		<input type="checkbox"/> CONFIDENTIAL <input type="checkbox"/> SECRET <input checked="" type="checkbox"/> GENERAL				
4	COVER1	1	PI	YELLOW	WITHIN: $1.5\text{mm} \pm 0.1\text{mm}$ OVER: $1.5\text{mm} \pm 0.2\text{mm}$	NAME: TACT SWITCH				
3	CONTACT	1	SUS	Ag-Plate	APPD: Yunfeng Fu 04/23/18	PART NO. TS5252-AADF-S4W26A				
2	TERMINAL	2	PHOSPHOR BRONZE	Ag-Plate	CHKD: Kai Zhang 04/23/18		UNIT	SCALE	SHEET	REV
1	CASE	1	LCP	BLACK	DR: Yong Zeng 04/23/18		mm	1:1	1/1	A

BEST TECHNOLOGY CO., LTD	文件编号 FILE NO.	YJ-CRS-005	页码 PEGE	1/7
	发布日期 DATE OF ISSUE	2018年04月09日		
PRODUCT SPECIFICATION 产品承认书	文件版本 EDITION	第C版第1次修订		

1. General Characteristics 一般特性:

适用范围:

1.1、This specification is applied to the requirements for TACTILE SWITCH (MECHANICAL CONTACT)

此规格书适用于机械式轻触开关的相关要求

1.2 Operating Temperature Range: -30°C to 85°C

使用温度范围: -30°C to 85°C

1.3 Operating Relative Humidity: ≤85%RH

相对湿度: ≤85%RH

1.4 Test Conditions: Unless otherwise specified, the atmospheric conditions for making measurements and tests are as follows:

实验条件: 若没有特别说明, 则试验大气条件如下:

Ambient Temperature: 5~35°C, Relative Humidity: 25~85%

环境温度: 5~35°C, 相对湿度: 25~85%

Air Pressure: 86~106Kpa (860~1060mbar)

大气压力: 86~106Kpa (860~1060mbar)

2. Appearance, Structure and Dimensions 外观, 结构及尺寸:

2.1 Appearance: The switch shall have good finishing, and no rust, crack or plating defects.

外观: 产品外观良好, 无锈蚀、裂纹和镀层缺陷。

2.2 Structure & Dimensions: Refer to individual product drawing.

结构及尺寸: 参见产品图纸

2.3 Markings: Refer to individual product drawing.

标识: 参见产品图纸。

3. Ratings 额定负荷

参见产品图纸

4. Electrical Characteristics 电气特性

No.	Item 项目	Criteria 标准	Test Method 实验方法
4.1	Contact Resistance 接触电阻	100mΩ Max.	在以DC 5V10mA 的直流电源或不低于 1KHz 的交流电源的电路中, 以一个等于 2 倍按力的静负荷施加于手柄中心 Applying a static load of 2 times operating force to the center of the stem, measurements shall be made by 5V DC 10mA or more than 1KHZ AC small-current contact resistance meter.
4.2	Resistance Insulation 绝缘电阻	100MΩ Min.	Measurement shall be made following application of 100V DC potential, across terminals, and across terminals and cover, for one minute. 在端子之间施加DC 100V /1min 的条件下, 测量端子之间底座、盖板的电阻值。
4.3	Dielectric Voltage 抗电强度	No dielectric breakdown shall occur. 无击穿现象发生。	Loading 250V (50-60Hz) AC between all insulated terminals Electricity lasts for 60 ± 5S. 在相互绝缘的所有接线端子之间加载 250V (50-60Hz) 交流电, 持续时间 60±5S。

BEST TECHNOLOGY Co.,LTD	文件编号 FILE NO.	YJ-CRS-005	页码 PAGE	2/7
	发布日期 DATE OF ISSUE	2018 年 04 月 09 日		
PRODUCT SPECIFICATION 产品承认书	文件版本 EDITION	第C 版第 1 次修订		

5. Mechanical Characteristics 机械特性			
No.	Item 项目	Criteria 标准	Test Method 实验方法
5.1	Operating Force 操作力	Refer to individual product drawing 参见产品图纸	Apply a static load on the midpoint of the actuator (or tip of the shaft) to supply a pressure vertically from its free position to operating position. 在操作元件末端沿操作方向均匀施加静载荷，使操作元件转换到动作位置。
5.2	Operation Position 操作行程	Refer to individual product drawing 参见产品图纸	开关垂直于操作方向放置，以一个等于 2 倍按力的静负荷施加在开关驱动件顶端中心，测量顶端移动的距离。 Placing the switch such that the direction of switch operation is vertical and then applying static load of 2times operating force to the center of the stem; the travel distance for the switch to come to a stop shall be measured.
5.3	Vibration Proof 振动	After test, Contact resistance:500 mΩMax. I No functional defective occur No abnormalities shall be recognized in appearance and construction. 实验后： 接触电阻：500 mΩ Max. 无功能性不良。 表面及结构无明显变形	Switch shall be secured to a testing machine by a normal mounting device and method. Switch shall be measured after following test. (1) Vibration frequency range 10~55 Hz (2) Total amplitude 1.5mm (3) Sweep ratio: 10~55~10Hz Approx. 1 min (4) Method of changing the sweep vibration frequency: logarithmic or linear (5) Direction of vibration: Three perpendicular directions including actuating direction. (6) Duration: 2 hours (6 hours in total) 开关采用常规的安装方法牢固地安装在试验设备上，并在下述参数条件下进行试验： (1) 振频 10-55Hz (2) 振幅 1.5mm (3) 振动变化速率：10-55-10Hz 大约 1 分钟 (4) 变频方法：对数或线性型式 (5) 振动方向：三个相互垂直的方向，其中一个方向应是促动元件运动的方向。 (6) 时间：每个方向 2 小时（共 6 小时）。

BEST TECHNOLOGY CO., LTD	文件编号 FILE NO.	YJ-CRS-005	页码 PAGE	3/7
	发布日期 DATE OF ISSUE	2018 年 04 月 09 日		
PRODUCT SPECIFICATION 产品承认书	文件版本 EDITION	第C 版第 1 次修订		

No.	Item 项目	Criteria 标准	Test Method 实验方法
5.4	Solder Ability 可焊性	More than 90% of immersed part shall be covered with solder. 超过 90% 的浸锡面积被焊料所覆盖。	<p>Switch shall be tested according to the following request:</p> <p>(1) Equipment: Auto-Dip Chamber</p> <p>(2) Solder: recommended M705-GRN360-K (LTD Sen Ju Metal Industry Co., Ltd.) or equivalent</p> <p>(3) Solder flux: recommended CF-110VH-2A (Tamura kaken)</p> <p>(4) Soldering Temperature: $255 \pm 5^{\circ}\text{C}$</p> <p>(5) stencil thickness: 0.1mm, The thickness of the solder paste: $\leq 0.1\text{mm}$</p> <p>(6) Soldering Time: $2 \pm 1\text{s}$</p> <p>(7) Immersion Depth: Immersion depth shall be at copper plating portion of PCB after mounting.</p> <p>(8) Prohibit contact items: alcohol, gasoline, Isophorone 开关在下述参数条件下进行试验:</p> <p>(1) 设备: 自动焊接机</p> <p>(2) 焊料: 推荐M705-GRN360-K (LTD森居金属工业有限公司) 或等效</p> <p>(3) 助焊剂: 推荐CF-110VH-2A (Tamura化研)</p> <p>(4) 焊接温度: $255 \pm 5^{\circ}\text{C}$</p> <p>(5) 建议钢网厚度为 0.1mm, 所刷锡膏厚度$\leq 0.10\text{mm}$。</p> <p>(6) 焊接时间: $2 \pm 1\text{s}$</p> <p>(7) 浸渍深度: 接线端应浸到开关根部处。</p> <p>(8) 禁止使用酒精, 汽油, 慢干水 (异佛尔酮) 等化学物品接触开关。</p>

BEST TECHNOLOGY CO., LTD	文件编号 FILE NO.	YJ-CRS-005	页码 PEGE	4/7
	发布日期 DATE OF ISSUE	2018年04月09日		
PRODUCT SPECIFICATION 产品承认书	文件版本 EDITION	第C版第1次修订		

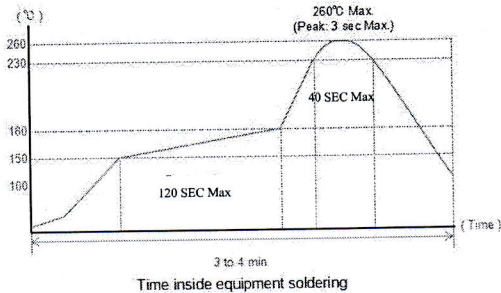
No.	Item 项目	Criteria 标准	Test Method 实验方法
5.5	Solder Heat Resistance 耐焊接热	No abnormalities shall be observed in appearance and operation. No functional defective occur 无外观及功能损坏。 无功能性不良。	<p>Please practice according to below condition:</p> <p>(1) Preheat :150°C-180°C 120S Max (2) Soldering heat : 260°C Max 3S. (3) Immersion depth: Up to the surface of the board</p> <p>焊接方法:</p> <p>(1) 预热: 150°C-180°C 120S Max (2) 最高焊接温度: 260°C Max 3S. (3) 浸渍深度: PCB 表面)</p> 
5.6	Resistance to Flux 抗助焊剂能力	Flux shall not be risen up to contact. The switch shall be free from abnormalities in operation. 焊剂不得上升进入开关内部, 影响接触转换。 试件在操作过程中不应发生变形。	<p>Switch shall be tested according to the following request:</p> <p>(1)Equipment: Auto-Dip Chamber (2)Solder: recommended M705-GRN360-K (LTD Sen Ju Metal Industry Co., Ltd.) or equivalent (3)Solder flux: recommended CF-110VH-2A (Tamura kaken) (4)Soldering Temperature: 255 ± 5°C (5)stencil thickness: 0.1mm, The thickness of the solder paste: ≤0.1mm (6)Soldering Time: 2 ± 1s (7)Immersion Depth: Immersion depth shall be at copper plating portion of PCB after mounting.</p> <p>开关在下述参数条件下进行试验:</p> <p>(1) 设备: 自动焊接机 (2) 焊料: 推荐M705-GRN360-K (LTD森居金属工业有限公司) 或等效 (3) 助焊剂: 推荐CF-110VH-2A (Tamura化研) (4) 焊接温度: 255 ± 5°C (5) 建议钢网厚度为 0.1mm, 所刷锡膏厚度 ≤ 0.10mm。 (6) 焊接时间: 2 ± 1s (7) 浸渍深度: 接线端应浸到开关根部处。</p>

BEST TECHNOLOGY CO., LTD	文件编号 FILE NO.	YJ-CRS-005	页码 PAGE	5/7
	发布日期 DATE OF ISSUE	2018年04月09日		
PRODUCT SPECIFICATION 产品承认书	文件版本 EDITION	第C版第1次修订		

6. Durability characteristics			
No.	Item 项目	Criteria 标准	Test Method 实验方法
6.1	Operating Life 动作寿命	After test, Contactresistance:1Ω Max. Insulation resistance: 10MΩ Min. Tolerance of operating force Disintegration shall be within 30% of specified value No functional defective occur The switch shall be free from abnormalities in appearance construction. 实验后: 接触电阻: 1 Ω Max. 绝缘电阻: 10M Ω Min. 操作力衰变应在±30%以内。 无功能性不良。 开关外观及结构应无损坏。	The upper limit of pressure according to the drawing, the stroke height is 6-10mm and the speed is 60 times/min, and continuous conversion on the life test equipment. Load:See product chart 根据图纸按压力度上限, 行程高度在 6-10mm, 速 度为 60次/分, 在寿命试验设备上连续转换, 次 数: 参见产品图纸
7. Weather Proof Characteristics 耐候性能:			
No.	Item 项目	Criteria 标准	Test Method 实验方法
7.1	Cold Proof 低温	After test, Contactresistance:1Ω Max. Insulation resistance: 10MΩ Min. No functional defective occur The switch shall be free from abnormalities in appearance &construction. 实验后: 接触电阻: 1 Ω Max. 绝缘电阻: 10M Ω Min. 无功能性不良。 开关外观及结构应无损坏。	After testing at -40 ± 2°C for 96 hours, the switch shall be allowed to stand under normal temperature and humidity conditions for 1 hour, and measurement shall be made within 1 hour after that. Water drops shall be eliminated. 试件在-40±2°C的温控箱内保持 96 小时, 然后在正 常温度和湿度下恢复 1 小时, 并在此后 1 小时内对 试品进行测量, 水滴应消失。
7.2	Hot Proof 高温	After test, Contactresistance:1Ω Max. Insulation resistance: 10MΩ Min. No functional defective occur The switch shall be free from abnormalities in appearance &construction. 实验后: 接触电阻: 1 Ω Max. 绝缘电阻: 10M Ω Min. 无功能性不良。 开关外观及结构应无损坏。	After testing at 90 ± 2°C for 96 hours, the switch shall be allowed to stand under normal temperature and humidity conditions for 1 hour, and measurement shall be made within 1 hour after that. 试件在 90±2°C的温控箱内保持 96 小时, 然后在正 常温度和湿度下恢复 1 小时, 并在此后 1 小时内对 试品进行测量, 水滴应消失。
7.3	Moisture Resistance 恒定湿热	After test, Contactresistance:1Ω Max. Insulation resistance: 10MΩ Min. No functional defective occur The switch shall be free from abnormalities in appearance &construction. 实验后: 接触电阻: 1 Ω Max. 绝缘电阻: 10M Ω Min. 无功能性不良。 开关外观及结构应无损坏。	After testing at 60± 2°C ,90~95% RH for 96 hours, the switch shall be allowed to stand under normal temperature and humidity conditions for 1 hour, and measurement shall be made within 1 hour after that. Water drops shall be eliminated. 试件在 60±2°C, 90-95%RH 的温控箱内保持96小 时, 然后在正常温度和湿度下恢复 1 小时, 并在此 后 1 小时内对试品进行测量, 水滴应消失。

BEST TECHNOLOGY CO., LTD	文件编号 FILE NO.	YJ-CRS-005	页码 PAGE	6/7
	发布日期 DATE OF ISSUE	2018年04月09日		
PRODUCT SPECIFICATION 产品承认书	文件版本 EDITION	第C版第1次修订		

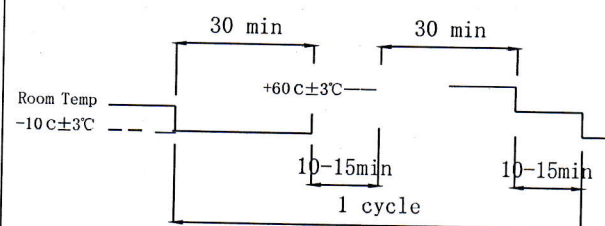
7. Durability characteristics			
No.	Item 项目	Criteria 标准	Test Method 实验方法
7.4	Temperature Cycling 温度转换	<p>After test, Contactresistance: 1Ω Max. Insulation resistance: 10MΩ Min. No functional defective occur The switch shall be free from abnormalities in appearance & construction. 实验后: 接触电阻: 1Ω Max. 绝缘电阻: 10MΩ Min. 无功能性不良。 开关外观及结构应无损坏。</p>	<p>After 5 cycles of following conditions, the switch shall be allowed to stand under normal temperature and humidity conditions for 1 hour, and measurement shall be made within 1 hour after that. Water drops shall be eliminated. 试件按下述实验条件试验 5 次, 然后在正常温度和湿度下恢复 1 小时, 并在此后 1 小时内对试品进行测量, 水滴应消失</p> 
7.5	Salt Mist 盐雾实验	<p>No remarkable corrosion shall be recognized in metal part. 在金属件上没有影响开关性能的斑点</p>	<p>The switch shall be checked after following test: (1) Temperature: 35±2°C (2) Salt Solution: 5%±1 (Solids by mass) (3) Duration: No action environment 24±1 hour After test, salt deposit shall be removed by running water. 试件在下述实验后测量: (1) 温度: 35±2°C (2) 盐溶液浓度: 5%±1 (质量百分比) (3) 时间: 无动作环境下 24±1 小时 实验后的盐沉积物用水冲掉。</p>

BEST TECHNOLOGY CO., LTD	文件编号 FILE NO.	YJ-CRS-005	页码 PAGE	7/7
	发布日期 DATE OF ISSUE	2018年04月09日		
PRODUCT SPECIFICATION 产品承认书	文件版本 EDITION	第C版第1次修订		

8. Other		
No.	Item 项目	Criteria 标准
8.1	Storage Condition 保存条件	<p>(1) Storage Environment -20 to 50 °C, 20 to 85%RH.(Storage in high temperature and high humidity shall be avoided.)</p> <p>(2) Storage Period Maximum of 3 months after shipment or six months in a plast bag (vinyl) that is not opened.</p> <p>(1) 保存环境 温度: -20 -50°C, 相对湿度 20-85%(应当避免高温高湿环境)。</p> <p>(2) 保存期 出货后拆开包装最多保存三个月 (拆开包装后尽量使用我司包装封口保存或者真空包装); 在未打开的塑料包装袋 (乙烯基) 内可保存六个月。</p>
8.2	Matters needing attention 注意事项	<p>(1) Diameter size of external key head/test head: the diameter of non-point series is suggested to be between 1.0mm-1.5mm, and the size of belt-point series is 20% larger than press-point series; the material is suggested to be hard material, otherwise it will affect the handle.</p> <p>(2) the deviation angle of the pressure is not more than 2°, which will result in drop and deviation.</p> <p>(3) it can not be subjected to lateral forces, which can lead to point drop and deviation.</p> <p>(4) please do not apply excessive load and impact to the switch.</p> <p>(5) avoid the use of sharp objects to press the cover film</p> <p>(6) it is not allowed to wash after the product is welded</p> <p>(7) avoid the switch for a long time in the ON state</p> <p>(1) 外接按键头部/测试头直径尺寸: 无点系列直径建议在 $\phi 1.0\text{mm}-\phi 1.5\text{mm}$ 之间, 带点系列建议比按点大20%以上; 材质建议为硬质材料, 否则会影响操作手感</p> <p>(2) 按压力度偏摆角度不超过2°, 会导致按点掉落, 偏位</p> <p>(3) 不能受到侧向的力量, 会导致按点掉落, 偏位</p> <p>(4) 请不要对开关施加过量负荷和冲击</p> <p>(5) 避免使用尖锐物体按压盖膜</p> <p>(6) 不允许在产品焊接后进行清洗</p> <p>(7) 避免开关长时间处于ON状态</p>